

DF-S3A DIRECT ACTING SPOOL, 3 WAY 2 POSITION

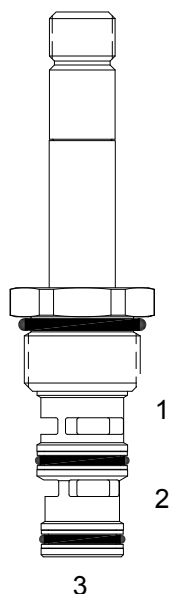

DESCRIPTION

10 size, 7/8-14 thread, "Delta" series, solenoid operated, 3 way 2 position, spool valve.

OPERATION

When de-energized the DF-S3A allows flow from (3) to (2) and blocks flow at port (1). When energized the valve allows flow from (1) to (3) and blocks flow at port (2).

OPERATION OF MANUAL OVERRIDE OPTION: to override, pull knob out. On the detented version, after pulling knob out twist 180 degrees and release. The valve will remain in that position.

FEATURES

- Hardened parts for long life.
- Efficient wet-armature construction.
- Cartridges are voltage interchangeable.
- Manual override option.
- Industry common cavity.
- Unitized, molded coil design.
- Continuous duty rated solenoid.
- Optional coil voltages and terminations.
- Optional "I" Coil: Weatherproof, Thermal Shock, Immersion Safe.

HYDRAULIC SYMBOL

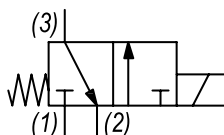

Common lift/lower valve where load holding is not required. For higher pressures see HF-S3A.

PERFORMANCE

Actual Test Data (Cartridge Only)

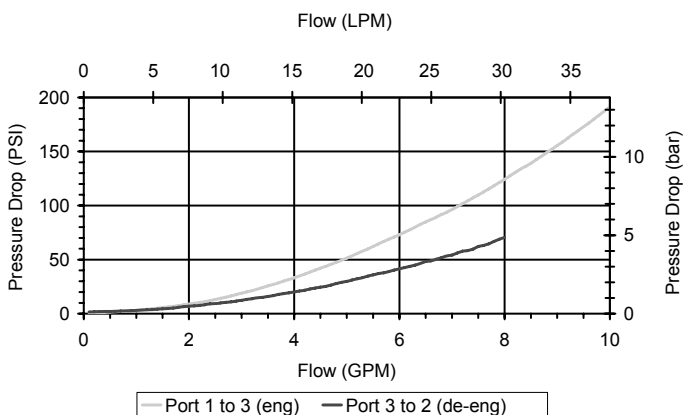

VALVE SPECIFICATIONS

Nominal Flow	10 GPM (38 LPM)
Rated Operating Pressure	3000 PSI (207 bar)
Typical Internal Leakage (150 SSU)	5 cu in/min (82 ml/min)
Viscosity Range	36 to 3000 SSU (3 to 647 cSt)
Filtration	ISO 18/16/13
Media Operating Temp. Range	-40° to 250°F (-40° to 120°C)
Weight	.28 lbs (.12 kg)
Operating Fluid Media	General Purpose Hydraulic Fluid
Cartridge Torque Requirements	30 ft-lbs (40.6 Nm)
Coil Nut Torque Requirements	4-6 ft-lbs (5.4-8.1 Nm)
Cavity	DELTA 3W
Cavity Tools Kit	
(form tool, reamer, tap)	40500001
Seal Kit	21191210

WARNING: the specifications/application data shown in our catalogs and data sheets are intended only as a general guide for the product described (herein). Any specific application should not be undertaken without independent study, evaluation, and testing for suitability.



4484 Boeing Drive Rockford, IL 61109 • USA • Phone +1 (815) 397-6628 • Fax +1 (815) 397-2526
mail: delta@delta-power.com • www.delta-power.com



Via Malavolti, 36 • 41122 Modena • ITALY • Phone +39 (059) 254895 • Fax +39 (059) 253512
mail: tecnord@tecnord.com • www.tecnord.com

SOLENOID OPERATED DIRECTIONAL CONTROLS

DIMENSIONS

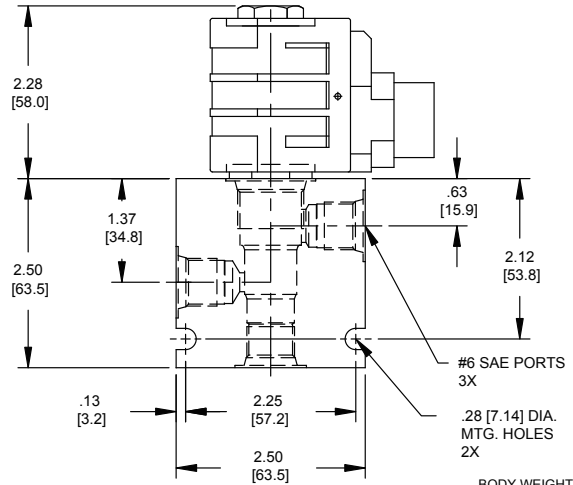
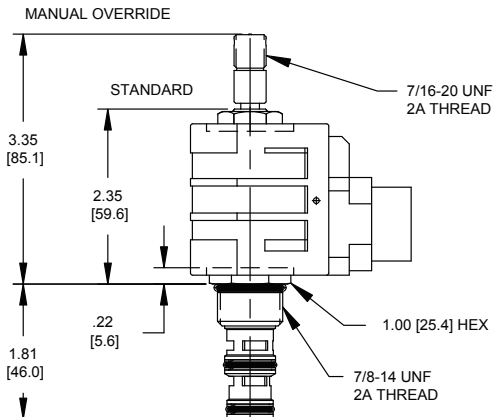
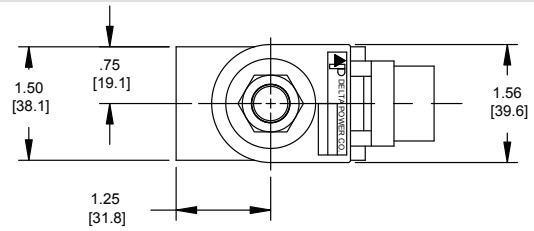
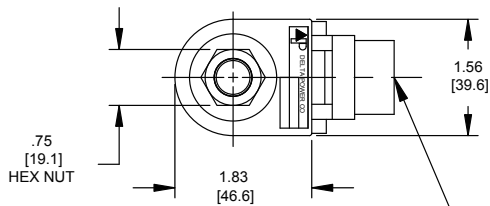

ORDERING INFORMATION

Approximate Coil Weight: .74 lbs (.33 kg)

DF-S3A

OPTIONS

- Buna Standard **00**
- Viton Standard **V0**
- Buna, Override, Detent **0M**
- Viton, Override, Detent **VM**
- Buna, Screen **A0**
- Viton, Screen **W0**
- Buna, Override, Nondetent **B1**
- Buna, Override, Nondetent **V1**
- Buna, Screen, Override, Nondetent **B3**
- Viton, Screen, Override, Nondetent **V3**
- Buna, Screen, Override, Detent **B4**
- Viton, Screen, Override, Detent **V4**

Note: use screen only if flow direction is from (1) to (2)

"D" COIL TERMINATION
(All DC Except as Noted)

BODIES

- Blank** Without Body
- N** 1/4 NPTF Ports
- S** #6 SAE Ports

VOLTAGE

- 06** 6 VDC
- 12** 12 VDC
- 24** 24 VDC
- 36** 36 VDC
- 48** 48 VDC
- 25** 24 VAC
- 11** 120 VAC
- 22** 220 VAC
- 44** 440 VAC

- DL** Double Lead
- DT** Deutsch on Leads DT04-2P
- ML** Metri-Pack on Leads
- PL** Packard on Leads
- WL** Weatherpack on Leads

- SS** Single Spade
- DS** Double Spade
- HC** DIN 43650 (Hirschmann) - (AC&DC)
- CL** Conduit Lead - (AC Only)
- DI** Deutsch - Integral DT04-2P

IMMERSION PROOF "D" TYPE

- IA** "I" Coil AMP Superseal - Integral
- ID** "I" Coil Deutsch - Integral DT04-2P
- IJ** "I" Coil AMP Jr. Timer - Integral
- IM** "I" Coil Metri-Pack - Integral

W 26 / 2019

WARNING: the specifications/application data shown in our catalogs and data sheets are intended only as a general guide for the product described (herein). Any specific application should not be undertaken without independent study, evaluation, and testing for suitability.



4484 Boeing Drive Rockford, IL 61109 • USA • Phone +1 (815) 397-6628 • Fax +1 (815) 397-2526
mail: delta@delta-power.com • www.delta-power.com



Via Malavolti, 36 • 41122 Modena • ITALY • Phone +39 (059) 254895 • Fax +39 (059) 253512
mail: tecnord@tecnord.com • www.tecnord.com